

1 B.P.M. Bellows Unit complete with mounts

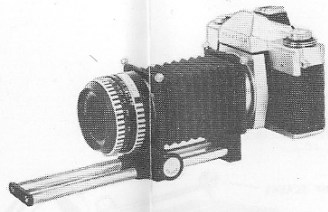

2 Bellows Unit with camera mounted forward

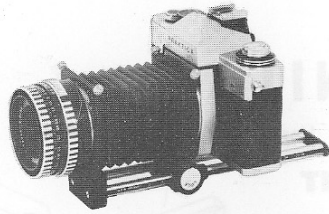

3 Bellows Unit with camera mounted reversed

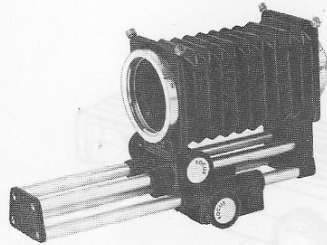

4 NEW B.P.M. BELLOWSIDE with underslide permanently fixed for utmost rigidity

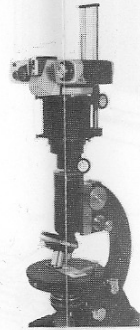

9 B.P.M. Microscope Adaptor

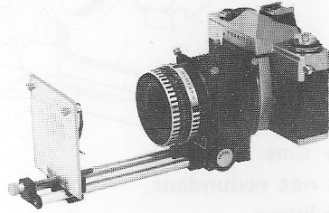

6 B.P.M. BELLOWS UNIT with REPROTRAN copy attachment

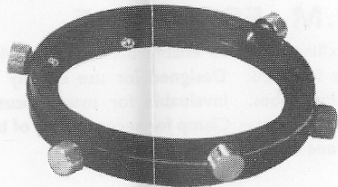

10 B.P.M. MOUNT CONNECTOR

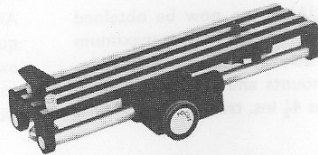

7 B.P.M. FOCUSLIDE

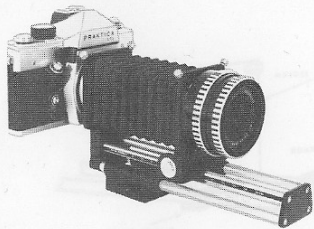

5 B.P.M. BELLOWSLIDE ready for use



11 B.P.M. MOUNT CONNECTOR in use

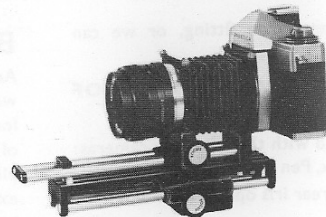

8 B.P.M. BELLOWS mounted on B.P.M. FOCUSLIDE

# B.P.M.

*Photographic Equipment*

PRECISION AIDS TO S.L.R.  
CLOSE-UP PHOTOGRAPHY  
AND COPYING

MADE IN ENGLAND

# B.P.M. UNIVERSAL BELLOWS UNIT

For use with most 35 mm. single lens reflex cameras with focal plane shutters and interchangeable lenses.

★ **2" x 2" SLIDE REPRODUCTION**

★ **TELEPHOTOGRAPHY**

★ **A 3 IN I EXTENSION UNIT**

★ **PRECISION ULTRA CLOSE-UPS**

Alloy Interchangeable Lens Mounts with quick precision location. Allows the unit to be used with the pillars in front or reversed back under the camera. This allows the camera lens to approach very close to the subject without the slide pillars protruding. See illustrations Nos. 2 and 3.

Each unit is supplied complete with one back and one front mount. Frame supplied for reproducing 35 mm. slides or copying negatives. Extension range from 30 mm. to 150 mm. (1 1/8 in. to 6 in.). Two tripod holes for balanced support.

One basic unit can be used on any of the following cameras with the use of our interchangeable lens mounts.

**BAYONET FITTINGS AVAILABLE:** Firstflex, Exakta, Exa, Praktina, Petriflex, Nikon F, Nikkormat, Nikkorex F, Nikon with Photomic Head, Minolta, Singlex, Alpa, Pen F, Pen FT, Yashica Pentamatic, Topcon R.E., Plusflex, Leicaflex, Leica M series, Argus, Canon Konica Autoreflex T, Icarex, Olympus OM series, Rolleiflex SL35, Pentax K, Contax RTS, Yashica FX, Miranda, Miranda Sensorex.

**STANDARD SCREW FITTINGS** available: 42 mm thread, Pentax, Praktica Auto, Zenith, Leica Screw, "C" & "D" cine lens mount.

**LEITZ LENS HEADS REVERSING RING MOUNTS** Thread sizes: 28.5 mm., 33 mm., 39 mm., 43 mm., 46 mm. Designed for using lenses inverted for optimum definition on extreme close-up work. Available in 39 mm., 40.5 mm., 44 mm., 46 mm., 48 mm., 49 mm., 52 mm., 55 mm. and 58 mm. filter mount.

**MOUNT CONNECTORS** One mount connector can be used to hold any two B.P.M. interchangeable mounts back to back to enable it to be used as a short extension tube. This enables the enthusiast to use the lenses from one camera on any other not originally intended. Ideal when a short extension is needed for close-ups of flowers, etc. See illustrations No. 10 and 11.

**MICROSCOPE ADAPTORS** Allows bellows or camera to be used on a microscope. Made in two parts to allow any standard 42 mm. screw fitting camera to fit directly on to the microscope or with the adaptor supplied the B.P.M. Bellows Unit can be used to give greater magnification. Illustration No. 9.

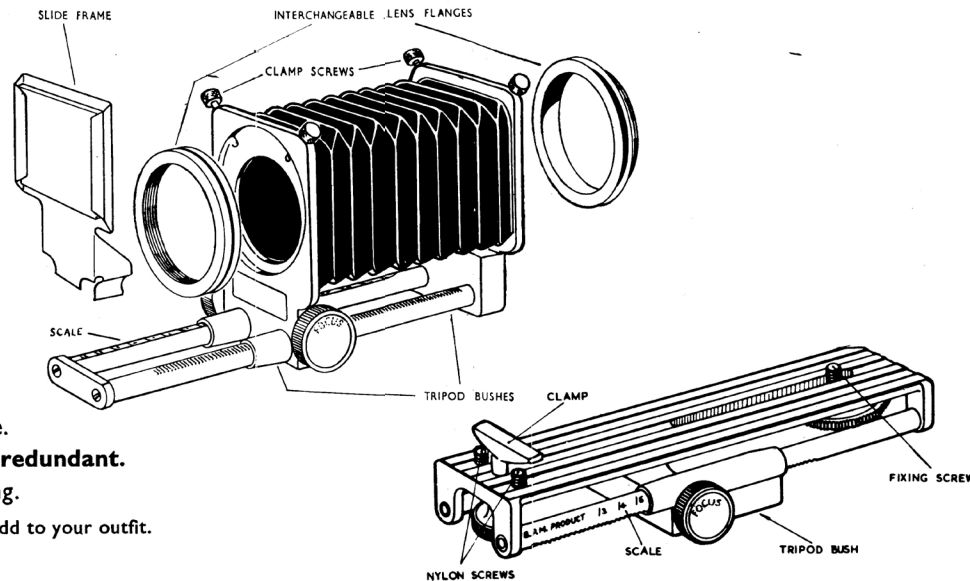

Extra mounts can be purchased at any time. If you change your camera this unit is **not redundant**. Just change the mounts to the new type fitting.

Purchase mounts as you need them for lenses as you add to your outfit.

## B.P.M. BELLOWSLIDE

**THE B.P.M. UNIVERSAL BELLOWS UNIT** can now be obtained with an extra slide under the bellows permanently fixed to give maximum rigidity. Rack and pinion focus to both the bellows and the underside. It takes our standard interchangeable lens mounts and has both English and Continental tripod fixings. Underside has 4 1/2 ins. travel. Illustrations 4 and 5.

**TELEPHOTOGRAPHY** Extra mounts can be made to suit non-standard lenses. This will allow lenses from old film or plate cameras to be used as long focus lenses. Any 3 in. to 6 in. lens without any means of focussing is suitable. The bellows becomes a focussing mount. Telephoto magnification can be found by dividing standard lens into focal length of long focus lens.

Blank mounts can be supplied for customers own fitting, or we can machine mounts to suit most special lenses.

**IT IS IMPORTANT TO STATE MAKE AND MODEL OF CAMERA WHEN ORDERING.**

Special mounts are supplied and must be used with the following cameras: Nikon, with photomic head, Miranda sensorex, Pen F.T., Praktica all models. All 42 mm. screw fitting lenses which have a rear iris opening pin will need a Praktica mount with inner flange.

## B.P.M. FOCUSLIDE

An auxiliary slide to enable bellows unit with camera attached to be accurately and quickly focussed. Designed for use on any S.L.R. camera with any bellows unit or extension tubes. Invaluable for macro-focus cine-cameras. 4 1/2 ins. of travel. Rack and pinion focus. Clamp for secure fixing of bellows unit. Solid lock. See illustrations Nos. 7 and 8.

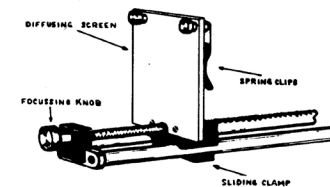

## B.P.M. REPROTRAN

Advanced copy attachment for use on the B.P.M. Universal Bellows Unit, for the serious worker, with a fine focussing screw for quick accurate focus of the original. Provision for copying uncut film. Slides can be placed in most positions for enlarging portion of a slide. Transparencies larger than 24 x 36 mm. can be reproduced to 35 mm. Complete with comprehensive instruction booklet. **SUPPLEMENTARY HOOD** for excluding light between lens and transparency available as an extra. Secured to camera lens with a B.P.M. reversing ring mount. See illustration No. 6.